

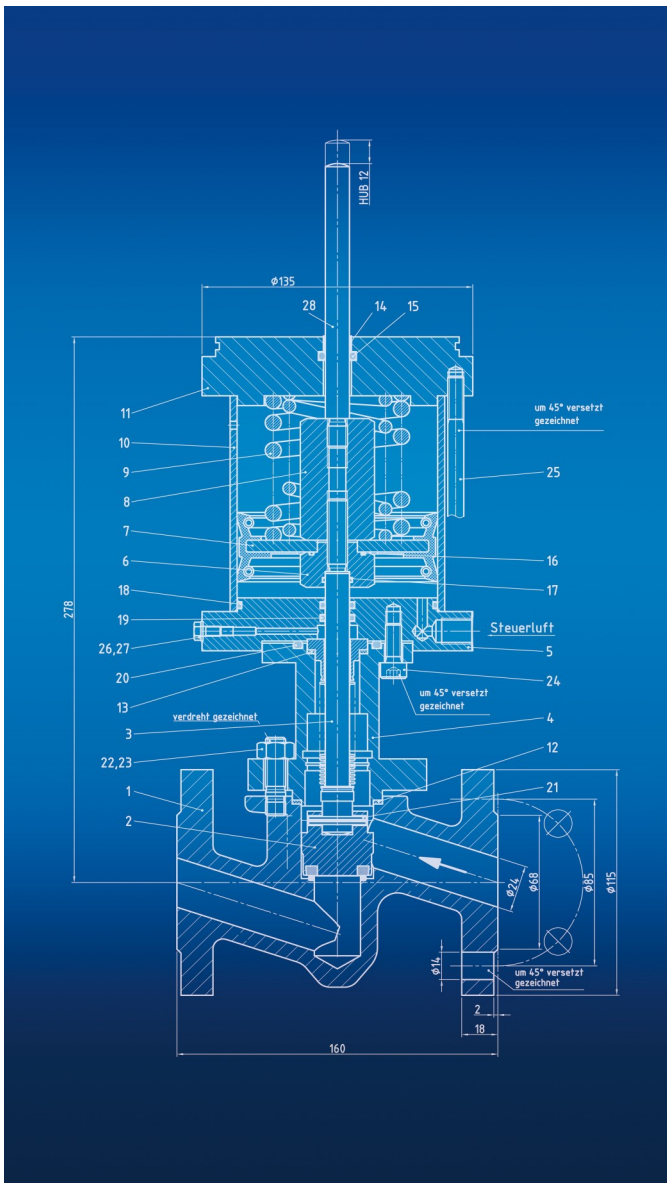

ALBRECHT-AUTOMATIK GMBH

Safety quick-closing valves for Steam

Installation example: Quick-closing ASV valve with 3/2-way solenoid valves and micro limit switches for "Open" and "Closed". ASV valve version with electro-pneumatic positioner. The safety quick-closing valve is available as a small poppet valve, impressing with its diverse properties. It is designed to prevent hazardous operating conditions and protect the plant. In the event of an auxiliary power failure, the valves close by spring force within **1 second** and in the control function within **5 seconds**.



Production series

ASV

Nominal diameters

DN 15, 20, 25

Inch 3/8", 3/4", 1"

KVAZ

DN 32, 40, 50

Inch 1 1/4", 1 1/2", 2"

Other sizes are available on request.

Accessories

Dirt trap

Nominal diameters

DN 15 to 300

inch 3/8" to 2"

Solenoid valves:

2/2-way, 3/2-way, 5/2 way

Bürkert

Norgren/Buschjost

Asco Numatics

Other manufacturers are available on request

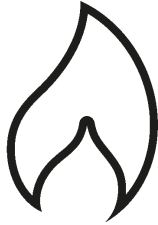

Areas of use:

steam



Operating temperature /

Ambient temperature:

-20 °C to +400 °C.

-20 °C to +80 °C.

Other temperatures on request.

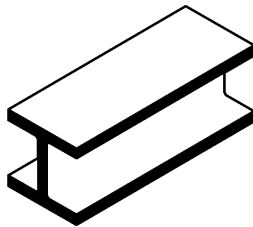

Housing material:

- DIN GP240GH (1.0619); P250GH (1.0460);
G-X6CrNiMo18 10 (1.4408);
X6CrNiMoTi17-12-2 (1.4571)
- ANSI A105, A216 WCB
Special materials
Material certification according to EN 10204

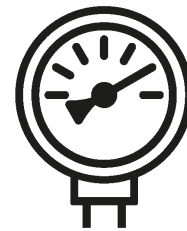

Operating pressure:

0 to 40 bar.

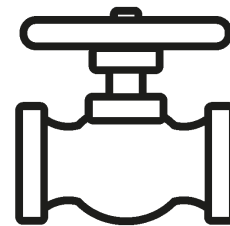

Valve housing:

DIN and ANSI flange connections
and welded ends.

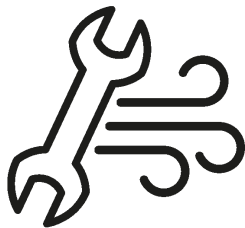

Control medium:

Filtered and anhydrous compressed air 3 to 10 bar.



Limit switch:

In accordance with the customer's requirements
(mechanical or initiator)

Switching and detection unit dimensions dependent on
design.

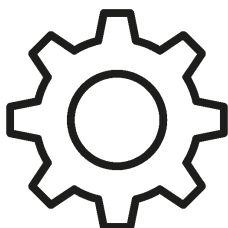

Non-standard models:

Larger nominal diameters and higher pressures are
available on request.



Valve spindle material:

-with bellows: X6CrNi1810 (1.4541) /
X6CrNiMoTi17-12-2 (1.4571)
and special materials.

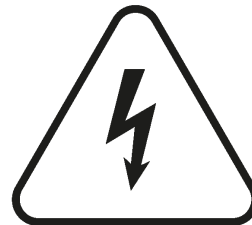

Control voltage:

24 VDC; 230 VAC other voltages are available on
request from DN100 with upstream quick-vent
valve.



Degree of protection:

IP65 Standard

ATEX Directive 2014/34/EU

Other protection classes are availa-
ble on request.



ALBRECHT-AUTOMATIK GMBH

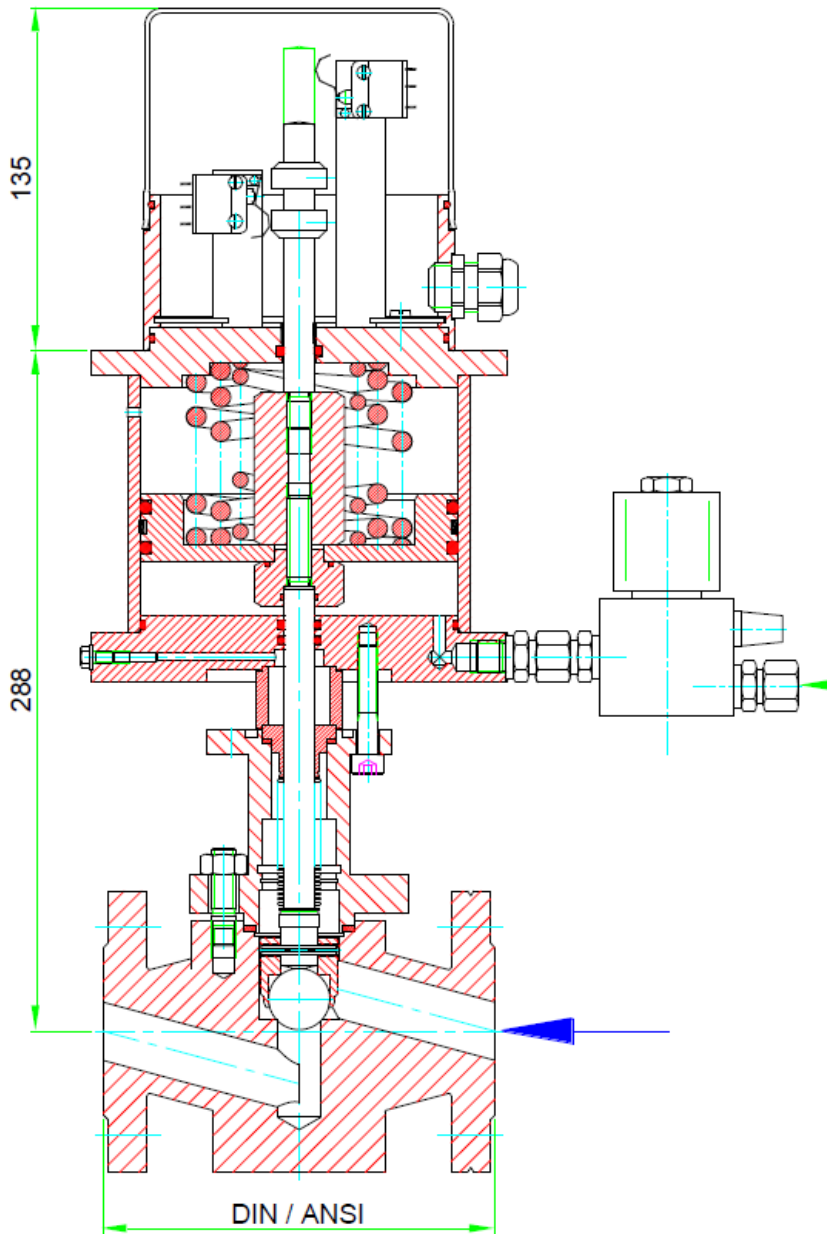

ASV/K

Installation example:

ASV/K with 3/2-way solenoid valve and micro limit switches for "Open" and "Closed"

DN	Overall length in mm		Weight in kg
	DIN PN 10-40	ANSI 300lbs	DIN PN10-40
15	130	152	18
20	150	178	20
25	160	203	21

Weight data for variant ASV/K without attachments

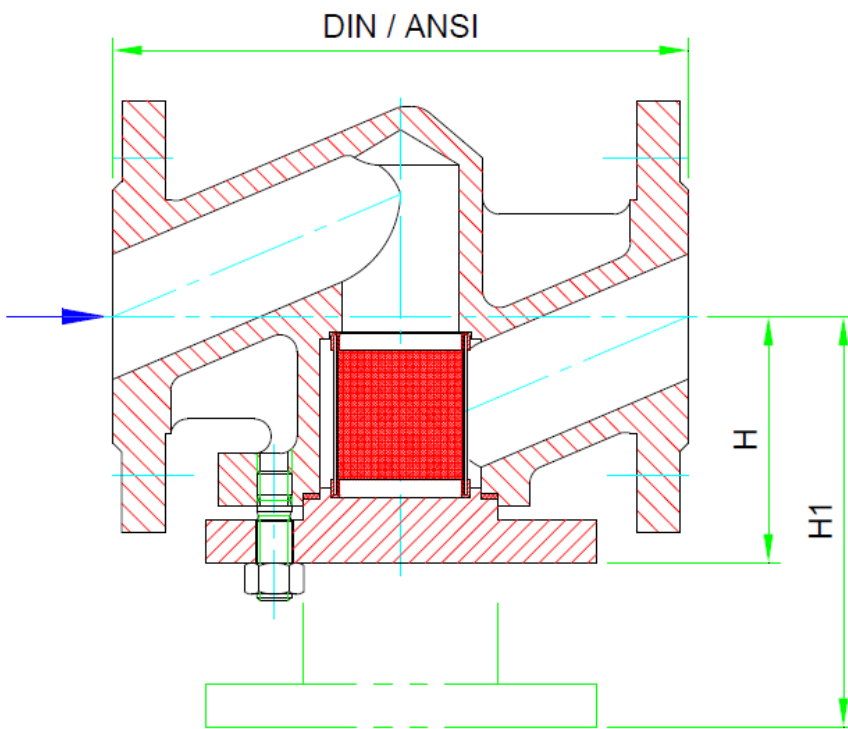

Dirt trap

Installation example: DN40

Installation example:

Dirt trap Straight seat
with replaceable screen basket.
With drain screw from DN65 onwards.

Note: A version with differential pressure display (visual or with electrical contact) is available to monitor the level of contamination.
Straight seat with replaceable screen basket.

	DN	15	20	25	32	40	50
	H	70	70	80	80	85	95
Dimension	H1	110	110	130	130	145	155
Overall lengths mm	DIN PN40	130	150	160	180	200	230
	ANSI 300lbs	152	178	203		229	267
Weight in kg	DIN PN40	4	5	6	7	10	12



ALBRECHT-AUTOMATIK GMBH

ASV-K

62A13II01

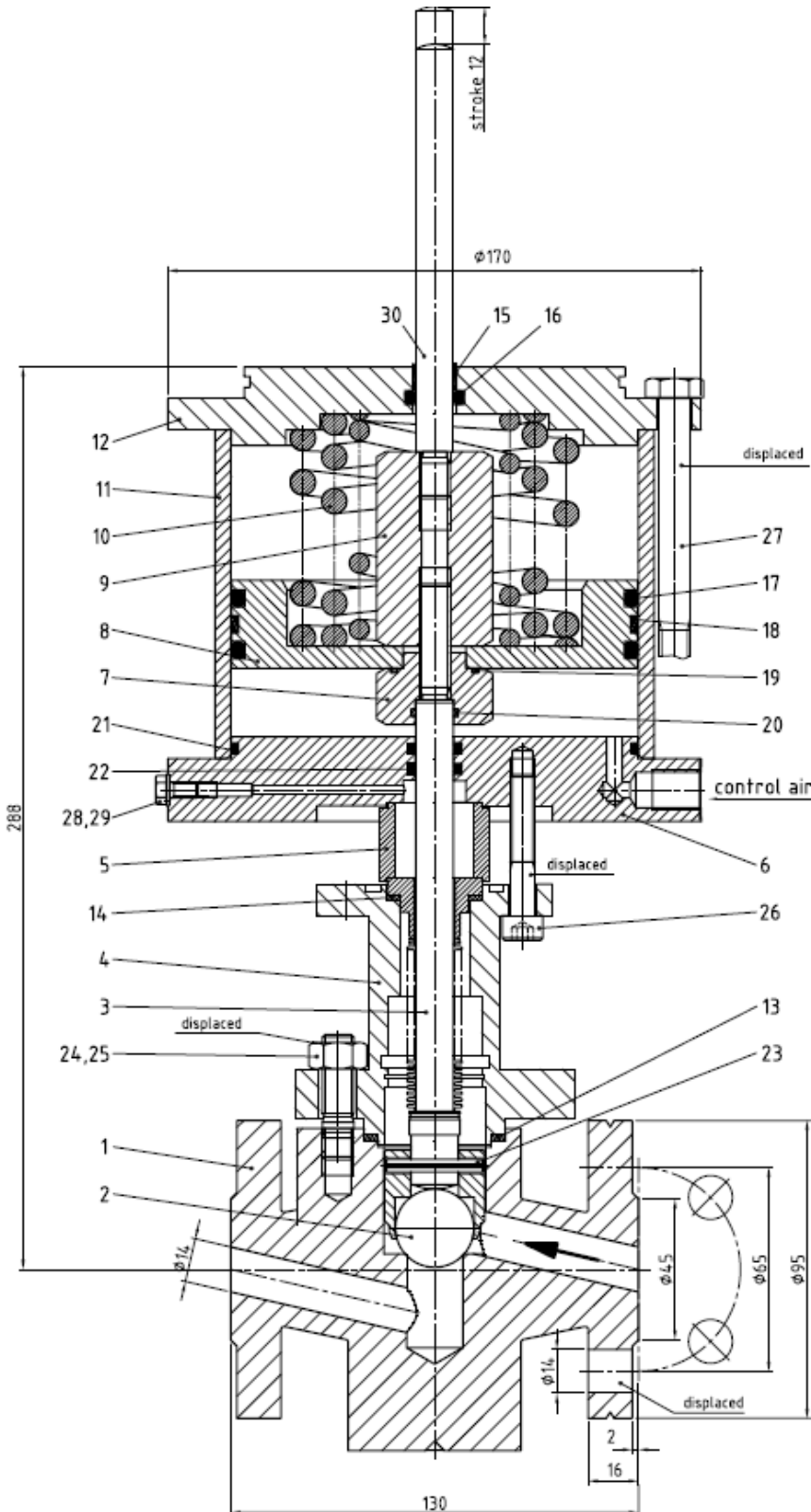

- 1 casing
- 2 valve cone
- 3 stem
- 4 center part
- 5 cooling part
- 6 bottom lid
- 7 base portion
- 8 control piston
- 9 piston nut
- 10 set of pressure springs
- 11 control tube
- 12 top lid
- 13 flat seal
- 14 flat seal
- 15 sliding bearing
- 16 o-ring
- 17 o-ring
- 18 guide strip
- 19 o-ring
- 20 o-ring
- 21 o-ring
- 22 o-ring
- 23 tension pin
- 24 stud bolt
- 25 hexagon nut
- 26 cylinder head screw
- 27 hexagon screw
- 28 hexagon screw
- 29 flat seal
- 30 adjust rod